

Operating instructions

UNIVERSAL CUTTING MILL

PULVERISETTE 19

Valid starting with: 19.10xx/0100



Read the instructions prior to performing any task!

Translation of the original operating instructions



Fritsch GmbH
Milling and Sizing
Industriestraße 8
55743 Idar-Oberstein
Telephone: +49 (0)6784/ 70-0
Fax: +49 (0)6784/ 70-11
email: info@fritsch.de
Internet: www.fritsch.de

Certifications and CE conformity

Certification

Fritsch GmbH has been certified by the TÜV-Zertifizierungsgemeinschaft e.V.



An audit certified that Fritsch GmbH conforms to the requirements of the DIN EN ISO 9001:2008.

CE Conformity

The enclosed Conformity Declaration lists the guidelines the FRITSCH instrument conforms to, to be able to bear the CE mark.



Table of contents

1	Basic structure.....	7
2	Safety information and use.....	9
	2.1 Requirements for the user.....	9
	2.2 Scope of application.....	9
	2.2.1 Operating principle.....	10
	2.3 Obligations of the operator.....	10
	2.4 Information on hazards and symbols used in this manual. .	11
	2.5 Device safety information.....	13
	2.6 Protective equipment.....	15
	2.6.1 Opening the cutting mill without mains connection.....	15
	2.7 Hazardous points.....	16
	2.8 Electrical safety.....	17
	2.8.1 General information.....	17
	2.8.2 Protection against restart.....	17
	2.8.3 Direction of rotation detection.....	17
	2.8.4 Overload protection.....	17
3	Technical data.....	18
	3.1 Dimensions.....	18
	3.2 Weight.....	18
	3.3 Operating noise.....	18
	3.4 Voltage.....	18
	3.5 Current consumption.....	18
	3.6 Power consumption.....	18
	3.7 Motor shaft power in accordance with VDE 0530, EN 60034.....	19
	3.8 Electrical fuses.....	19
	3.9 Material.....	19
	3.10 Final fineness.....	19
	3.11 Speed.....	19
4	Installation.....	20
	4.1 Transport.....	20
	4.2 Unpacking.....	20
	4.3 Setting up.....	20
	4.4 Ambient conditions.....	20
	4.5 Fastening the Universal Cutting Mill.....	21
	4.6 Selecting and converting the funnels.....	21
	4.6.1 Selecting the funnel.....	21
	4.6.2 Converting from standard funnel to protected funnel.....	22
	4.6.3 Converting from protected funnel to standard funnel.....	22
	4.7 Electrical connection.....	23

5	Initial start-up	25
5.1	Before switching on for the first time.....	25
5.2	Switching on.....	26
5.3	Function check.....	26
5.4	Switching off.....	26
6	Using the device	28
6.1	Preparing a comminution.....	28
6.1.1	Opening the cutting mill.....	28
6.1.2	Inserting / changing the fixed knives.....	29
6.1.2.1	Installation position of the fixed knives.....	29
6.1.2.2	Installation position of the fixed knives with tungsten carbide cutting edge.....	30
6.1.3	Setting the gap width of the knives.....	30
6.1.4	Inserting / changing a rotor.....	31
6.1.5	Inserting / changing a sieve cassette.....	33
6.1.5.1	Selecting the sieve cassette.....	33
6.1.6	Closing the cutting mill.....	34
6.1.7	Checking if the rotor is turning freely.....	34
6.2	Comminution procedure with standard funnel.....	35
6.2.1	Using the plunger.....	36
6.3	Comminution procedure with the protected funnel.....	36
6.4	Overload of the cutting mill.....	37
6.5	Sample exhaust system with cyclone separator.....	39
7	Cleaning	42
7.1	Housing.....	42
7.2	Cutting chamber.....	42
7.3	Funnel.....	43
7.3.1	Standard funnel (1).....	43
7.3.2	Protected funnel (22).....	44
7.3.2.1	Removing sample pusher (24).....	44
7.3.2.2	Removing the plunger (23).....	45
7.4	Collecting vessel.....	45
7.5	Cleaning the sample exhaust system and cyclone separator.....	46
7.6	Cleaning the filter foam mat (B).....	46
8	Maintenance	47
9	Repairs	51
9.1	Checklist for troubleshooting.....	51
10	Disposal	53
11	Guarantee terms	54
12	Exclusion of liability	56

Table of contents

13	Safety logbook.....	58
14	Index.....	60

1 Basic structure

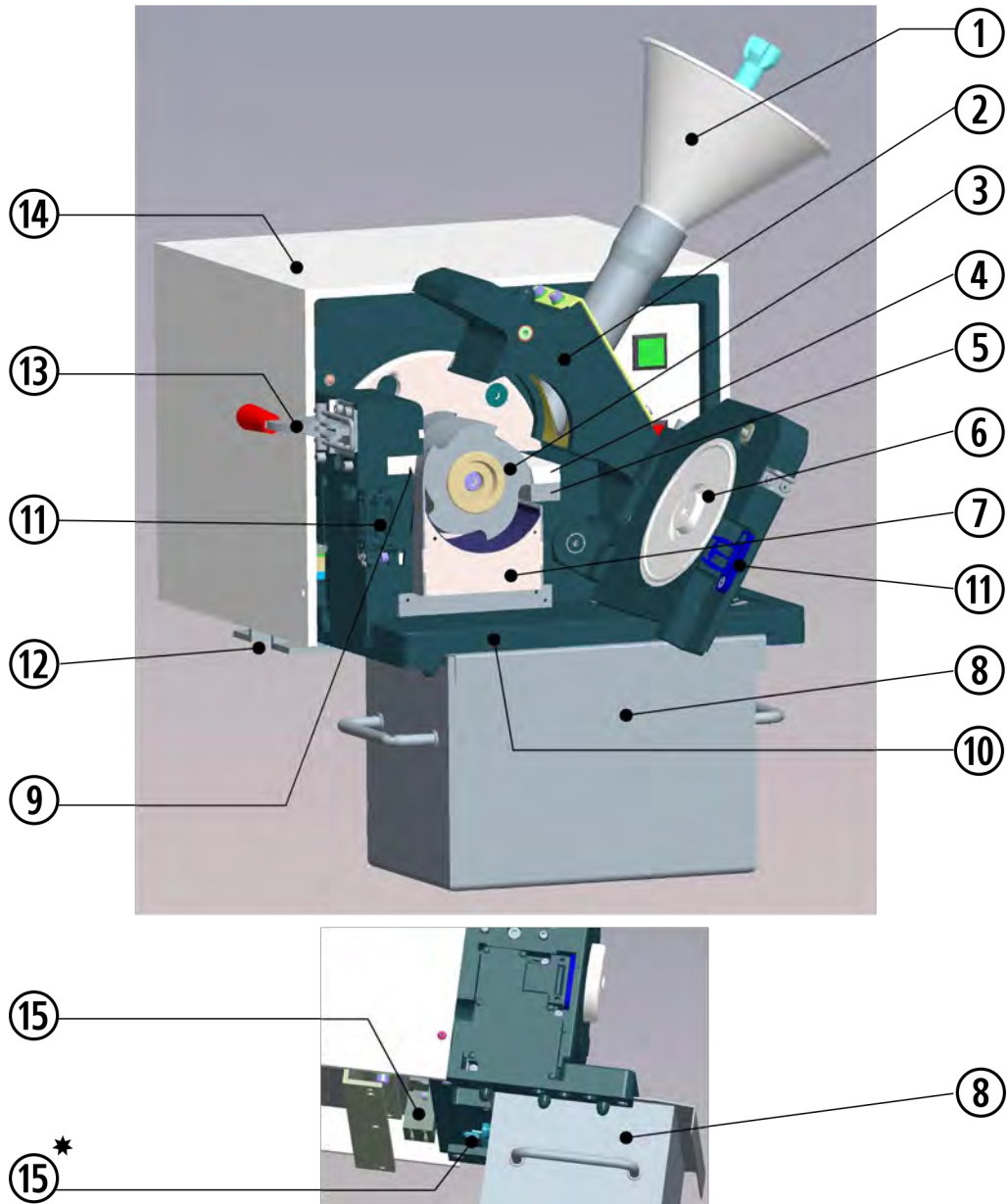

- | | | | |
|---|-----------------------|-----|-----------------------|
| 1 | Standard funnel | 9 | Fixed knife 2 |
| 2 | Upper part of housing | 10 | Lower part of housing |
| 3 | Rotor | 11 | Lock |
| 4 | Fixed knife 1 | 12 | U-profile |
| 5 | Fixed knife 2 | 13 | Latch clamp |
| 6 | Closing lid | 14 | Motor cover |
| 7 | Sieve cassette | 15 | Safety switch |
| 8 | Collecting vessel | 15* | Safety switch bracket |

Basic structure

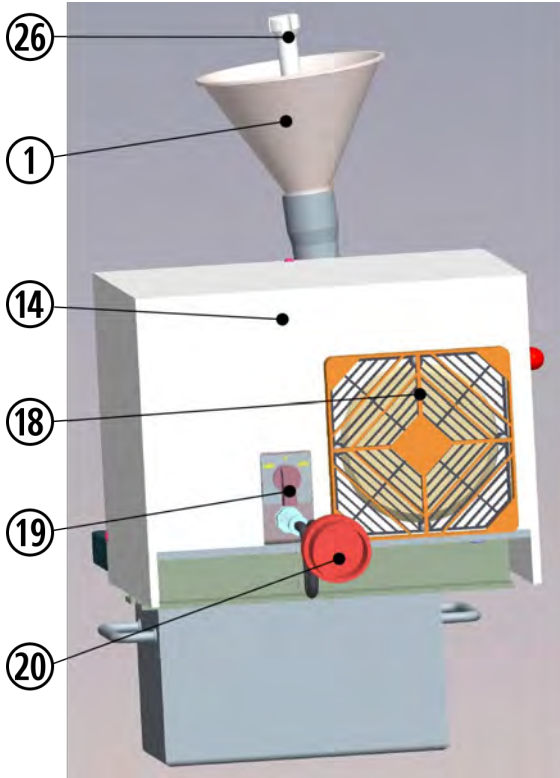

- 1 Standard funnel
- 14 Motor cover
- 18 Ventilation grid
- 19 Control switch
- 20 Mains plug

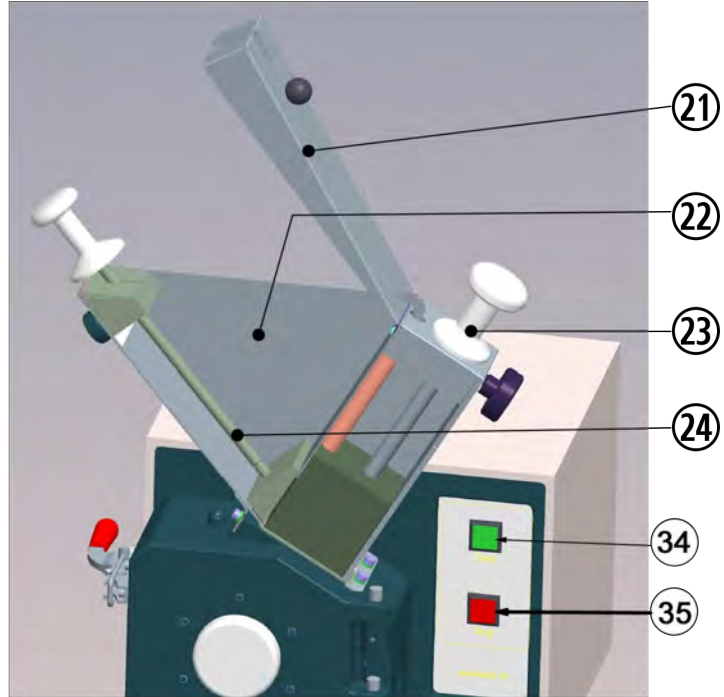

- 21 Funnel lid
- 22 Protected funnel
- 23 Plunger (protected funnel)
- 24 Sample pusher
- 26 Plunger (standard funnel)
- 34 Start button
- 35 Stop button

2 Safety information and use

2.1 Requirements for the user

This operating manual is intended for persons assigned with operating and monitoring the Fritsch PULVERISETTE 19. The operating manual and especially its safety instructions are to be observed by all persons working on or with this device. In addition, the applicable rules and regulations for accident prevention at the installation site are to be observed. Always keep the operating manual at the installation site of the PULVERISETTE 19.

People with health problems or under the influence of medication, drugs, alcohol or exhaustion must not operate this device.

The PULVERISETTE 19 may only be operated by authorised persons and serviced or repaired by trained specialists. All commissioning, maintenance and repair work may only be carried out by technically qualified personnel. Qualified personnel are persons who, because of their education, experience and training as well as their knowledge of relevant standards, regulations, accident prevention guidelines and operating conditions, are authorised by those responsible for the safety of the machine to carry out the required work and are able to recognize and avoid possible hazards as defined for skilled workers in IEC 364.

In order to prevent hazards to users, follow the instructions in this manual.

Malfunctions that impair the safety of persons, the PULVERISETTE 19 or other material property must be rectified immediately. The following information serves both the personal safety of operating personnel as well as the safety of the products described and any devices connected to them: All maintenance and repair work may only be performed by technically qualified personnel.

This operating manual is not a complete technical description. Only the details required for operation and maintaining usability are described.

Fritsch has prepared and reviewed this operating manual with the greatest care. However, no guarantee is made for its completeness or accuracy.

Subject to technical modifications.

2.2 Scope of application

The Universal Cutting Mill can be used for the fast comminution of soft, medium-hard, brittle, tough and fibrous materials like:

Sheet rubber, plastics, refuse-derived fuel, dry meat, leather, wood, coal, malt, paper/cardboard, peat, animal feed, pasta, tablets, leaves, pellets, spices, fabric, straw, maize, bones, roots, tobacco...

2.2.1 Operating principle

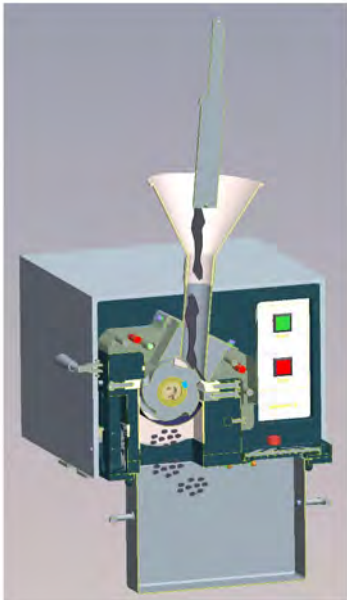

The material is fed through a funnel (example in image with standard funnel) into the cutting chamber. There, rotating knives (3) in combination with fixed knives (4,5,9) cut the material. The fine ground material falls through a sieve cassette (7) into the collecting vessel (8).

For fine comminution, the sample exhaust system can be used with cyclone separator (optional accessory 45.5900.00).

2.3 Obligations of the operator

Before using the PULVERISETTE 19, this manual is to be carefully read and understood. The use of the PULVERISETTE 19 requires technical knowledge; only commercial use is permitted.

The operating personnel must be familiar with the content of the operating manual. For this reason, it is very important that these persons actually receive the present operating manual. Ensure that the operating manual is always near the device.

The PULVERISETTE 19 may exclusively be used within the scope of applications set down in this manual and within the framework of guidelines put forth in this manual. In case of non-compliance or improper use, the customer assumes full liability for the functional capability of the PULVERISETTE 19 and for any damage or injury arising from failure to fulfil this obligation.

By using the PULVERISETTE 19 the customer agrees with this and recognizes that defects, malfunctions or errors cannot be completely excluded. To prevent risk of damage to persons or property or of other direct or indirect damage, resulting from this or other causes, the customer must implement sufficient and comprehensive safety measures for working with the PULVERISETTE 19.

Neither compliance with this manual nor the conditions and methods used during installation, operation, use and maintenance of the PULVERISETTE 19 can be monitored by Fritsch GmbH. Improper execution of the installation can result in property damage and thus endanger persons. Therefore, we assume absolutely no responsibility or liability for loss, damage or costs that result from errors at installation, improper operation or improper use or improper maintenance or are in any way connected to these.

The applicable accident prevention guidelines must be complied with.
Generally applicable legal and other obligatory regulations regarding environmental protection must be observed.

2.4 Information on hazards and symbols used in this manual

Safety information

Safety information in this manual is designated by symbols. Safety information is introduced by keywords that express the extent of the hazard.

**DANGER!**

This symbol and keyword combination points out a directly hazardous situation that can result in death or serious injury if not avoided.

**WARNING!**

This symbol and keyword combination points out a possibly hazardous situation that can result in death or serious injury if not avoided.

**CAUTION!**

This symbol and keyword combination points out a possibly hazardous situation that can result in slight or minor injury if not avoided.

**NOTICE!**

This symbol and keyword combination points out a possibly hazardous situation that can result in property damage if not avoided.

**ENVIRONMENT!**

This symbol and keyword combination points out a possibly hazardous situation that can result in environmental damage if not avoided.

Special safety information

To call attention to specific hazards, the following symbols are used in the safety information:

Safety information and use



DANGER!

This symbol and keyword combination points out a directly hazardous situation due to electrical current. Ignoring information with this designation will result in serious or fatal injury.



DANGER!

This symbol and keyword combination designates contents and instructions for proper use of the machine in explosive areas or with explosive substances. Ignoring information with this designation will result in serious or fatal injury.



DANGER!

This symbol and keyword combination designates contents and instructions for proper use of the machine with combustible substances. Ignoring information with this designation will result in serious or fatal injury.



WARNING!

This symbol and keyword combination points out a directly hazardous situation due to movable parts. Ignoring information with this designation can result in hand injuries.



WARNING!

This symbol and keyword combination points out a directly hazardous situation due to hot surfaces. Ignoring information with this designation can result in serious burn injuries due to skin contact with hot surfaces.

Safety information in the procedure instructions

Safety information can refer to specific, individual procedure instructions. Such safety information is embedded in the procedure instructions so that the text can be read without interruption as the procedure is being carried out. The keywords described above are used.

Example:

1. ➔ Loosen screw.

2. ➔



CAUTION!
Risk of entrapment at the lid.

Close the lid carefully.

3. ➔ Tighten screw.

Tips and recommendations



This symbol emphasises useful tips and recommendations as well as information for efficient operation without mal-function.

Further designations

To emphasise procedure instructions, results, lists, references and other elements, the following designations are used in this manual:

Designation	Explanation
➔ 1., 2., 3. ...	Step-by-step procedure instructions
⇒	Results of steps in the procedure
↪	References to sections in this manual and relevant documentation
■	Lists without a specific order
[Button]	Operating elements (e.g. push button, switch), display elements (e.g. signal lamps)
'Display'	Screen elements (e.g. buttons, function key assignment)

2.5 Device safety information

Please observe!

- Only use original accessories and original spare parts. Failure to observe this instruction can compromise the safety of the machine.
- Accident-proof conduct is to be strictly followed during all work.
- Comply with all currently applicable national and international accident prevention guidelines.

Safety information and use



CAUTION!

Wear hearing protection!

If a noise level of 85 dB(A) is reached or exceeded, ear protection should be worn to prevent hearing damage.



WARNING!

The maximum accepted concentration (MAC) levels of the relevant safety guidelines must be observed; if necessary, ventilation must be provided or the machine must be operated under an extractor hood.



DANGER!

Explosion hazard!

- When Comminution oxidizable substances, e.g. metals or coal, there is a risk of spontaneous combustion (dust explosion) if the share of fine particles exceeds a certain percentage. When Comminution these kinds of substances, special safety measures must be taken and the work must be supervised from a specialist.
- The PULVERISETTE 19 is not explosion protected and is not designed to comminute explosive materials.

- Do not remove the information signs.



NOTICE!

Immediately replace damaged or illegible information signs.

- Unauthorised alteration of the PULVERISETTE 19 will void Fritsch's declaration of conformity to European directives and void the guarantee.
- Only use the PULVERISETTE 19 when it is in proper working order, as intended and in a safety- and hazard-conscious manner adhering to the operating manual. In particular, immediately rectify any malfunctions that could pose a safety hazard.
- If, after reading the operating manual, there are still questions or problems, please do not hesitate to contact our specialised personnel.

2.6 Protective equipment

- Protective equipment is to be used as intended and may not be disabled or removed.
- All protective equipment is to be regularly checked for integrity and proper functioning.
- The Universal Cutting Mill is equipped with a safety lock (11) which also protects the operator. This locks the front closing lid (6) during operation.
- The safety switches (11, 15) prevent operation of the Universal Cutting Mill, if the cutting chamber is not closed or a collecting vessel (8) has not been inserted.
- **Do not operate the device without a funnel (1 or 22)!**
Funnels (1, 22) are mechanical safety devices that enable hazard-free filling.
- When changing the funnels (1, 22), disconnect the device from the mains and install the new funnel (1, 22) immediately! (↪ Chapter 4.6 'Selecting and converting the funnels' on page 21)
- Motor safety switch (↪ Chapter 6.4 'Overload of the cutting mill' on page 37)

2.6.1 Opening the cutting mill without mains connection

**DANGER!**

The lock (11) must only be released manually when the closing lid (6) is closed.

The latch clamp (13) of the door must be locked!



1. ➤ Insert the supplied triangular key into the bore hole under the safety lock (11) and turn it clockwise.
2. ➤ The closing lid (6) can be opened after opening the latch clamp (13).

Safety information and use

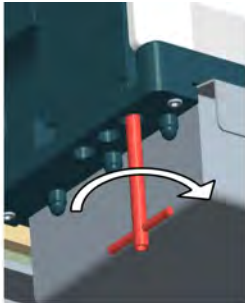

3. ➤ At this time, it is not possible to switch on the Universal Cutting Mill. To switch it on, the safety lock (11) must be activated by turning the triangular key to the left, the closing lid (6) must be closed and the latch clamp (13) in locked position.

2.7 Hazardous points

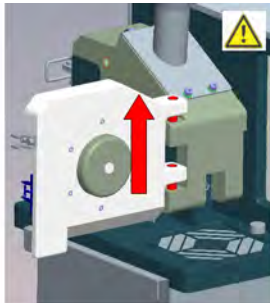

- The closing lid (6) can be lifted out of the hinges. When opening the upper part of the housing (2) it is possible to leave the closing lid (6) in the hinge. If this is the case, ensure that the closing lid (6) does not lift out of the hinge when opening the upper part of the housing (2).



- When opening the upper part of the housing (2), there is an initial resistance.
- Make sure that the closing lid (6) is fully open!

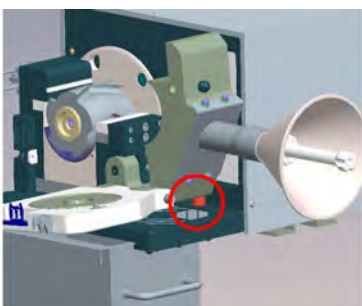

- When opening the upper part of the housing (2), slowly swivel it open until the upper part of the housing (2) is resting on the rubber buffer - do not let it fall down heavily.
- Crushing hazard when closing the upper part of the housing (2). Close it slowly!

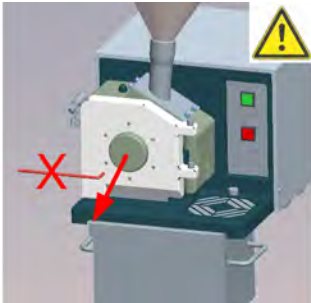

- After checking if the rotor (3) is turning freely (↪ *Chapter 6.1.7 'Checking if the rotor is turning freely' on page 34*), the required hexagonal socket screw key must be removed immediately.

2.8 Electrical safety

2.8.1 General information



- The switch (19) on the back is not a main switch but rather a control switch. Therefore the mains plug (20) must be plugged out in order to safely disconnect the supply voltage.
- Switch the control switch (19) on the back of the Universal Cutting Mill to 0, if the device is to be idle for a longer period of time (e.g. overnight).

2.8.2 Protection against restart

In the case of power failure during operation or after switching off with the control switch (19), the closing lid (6) is locked. The lock (11) is opened when power returns. However, for safety reasons the cutting mill does not restart.

2.8.3 Direction of rotation detection

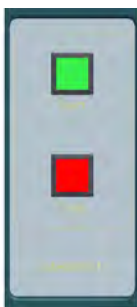

A unit for detection of the direction of rotation is installed in devices with a three-phase motor:

If the STOP button (35) lights up red after connecting to a three-phase power system and switching the control switch (19) to AUTO, the direction of rotation must be corrected. To do this, two phases in the mains plug must be reversed. ↪ *Chapter 4.7 'Electrical connection' on page 23.*

2.8.4 Overload protection

- The motor protection switch switches off if overload occurs. ↪ *Chapter 6.4 'Overload of the cutting mill' on page 37.* The STOP button lights up red.

Technical data

3 Technical data

3.1 Dimensions

440 mm x 550 mm x 630 mm
(width x depth x height)

3.2 Weight

- 56 - 65 kg (net)
- 86 - 95 kg (gross)

3.3 Operating noise

The noise level is approx. 78 dB (A) when idle and 95 dB (A) when idle incl. cyclone separator. The value fluctuates strongly depending on the comminution material.

3.4 Voltage

- 400V / 3~
- 230V / 1~
- 100-120V / 1~

3.5 Current consumption

- 16A for 400V / 3~ motor
 - 16A for 230V / 1~ motor
 - 15A for 100-120V / 1~ motor
- (↪ Chapter 4.7 'Electrical connection' on page 23)

Transient overvoltage according to overvoltage category II is permitted.

3.6 Power consumption

- 3240 W for 400V / 3~ motor
- 2000 W for 400V / 3~ motor
- 2200 W for 230V / 1~ motor
- 1850 W for 100-120V / 1~ motor

3.7 Motor shaft power in accordance with VDE 0530, EN 60034

- 2.2 kW for 400V / 3~ motor
- 1.5 kW for 400V / 3~ motor
- 1.5 kW for 230V / 1~ motor
- 1.1 kW for 100-120V / 1~ motor

3.8 Electrical fuses

- Circuit breaker in device
- Micro-fuse in device
- Motor safety switch (↪ Chapter 6.4 'Overload of the cutting mill' on page 37)
- Direction of rotation detection in three-phase model (↪ Chapter 2.8 'Electrical safety' on page 17)

3.9 Material

Feed size

Depending on material and funnel (1, 22) up to 70 x 80 mm. Harder material max. 10 mm.

Batchwise feeding!

Throughput

Depending on material property and sieve used, up to 60 l/h.

3.10 Final fineness

Achievable average final fineness depending on sieve insert, 0.2 - 6 mm.

3.11 Speed

50 Hz	60 Hz	Order No.:
302 -	1168 rpm/min	19.108x.00
2800 -	3400 rpm/min	19.10x0.00

4 Installation

4.1 Transport

- Transport on transport palette with a forklift or pallet truck.
- When lifting the device hold it underneath at the back and front only. Do not lift it using the plastic cover.



CAUTION!

When lifting, at least 2 persons are required!

4.2 Unpacking

- Pull out the nails that fasten the crate to the transport pallet.
- Lift the crate off the transport pallet.
- Compare the contents of the delivery with your order.

4.3 Setting up

- 4 screws connect the cutting mill to the transport pallet. Remove the 4 screws.
- Lift the cutting mill off the transport pallet.



CAUTION!

At least 2 persons are required to lift it off!

4.4 Ambient conditions



- The device may only be operated indoors.
- The surrounding air may not carry any electrically conductive dust.
- The room temperature should be between 5 and 40 °C.
- Altitudes up to 2000 m NN.
- Maximum relative humidity 80% for temperatures up to 31 °C, linearly decreasing down to 50% relative humidity at 40 °C.
- Degree of pollution 2 according to IEC 664.

4.5 Fastening the Universal Cutting Mill

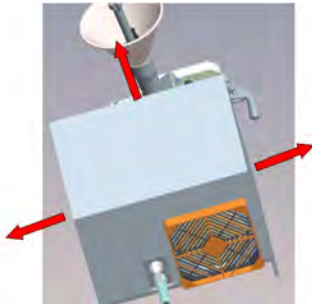

Screw the cutting mill tightly to the stand provided (acc. to instructions) or to a stable mount (table...). The following must be observed in order to fasten the device:

- Unscrew the 3 screws fastening the motor cover (14).
- Lift the motor cover (14) off carefully.



- Two U-profiles (12) are mounted on the bottom of the device. Insert the 4 screws provided through the bore holes in the U-profiles (12) and screw them tightly to the stand or table. Other screws with the same diameter can also be used.

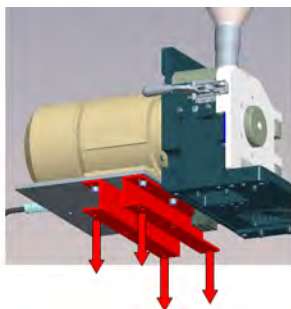

WARNING!

Ensure that the device is safely fastened. Sizeable lateral forces can occur!



NOTICE!

Make sure that the Universal Cutting Mill is easily accessible. On the right of the mill there must be enough space to lift open the upper part of the housing (2) incl. funnel (1, 22).

Keep the ventilation grate (18) on the back free. Risk of overheating!

4.6 Selecting and converting the funnels

4.6.1 Selecting the funnel

The standard funnel (1) is used for long and bulk solids, for free-flowing material, but also for the comminution of long goods, like for example straw or wood. The protected funnel (22) is used for all other materials.

Installation

4.6.2 Converting from standard funnel to protected funnel

1. ➤ Close the cutting mill.
2. ➤ Switch the control switch (19) on the back of the device to 0.
3. ➤ Remove the mains plug (20).
4. ➤ Unscrew the four M6x12 hexagon bolts fastening the standard funnel (1) to the upper part of the housing (2) using a hexagon socket screw key and lift off the standard funnel (1).

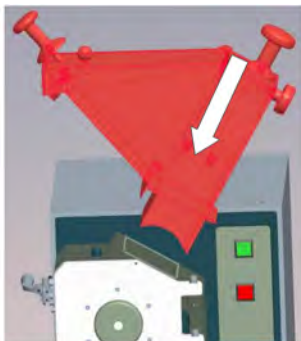
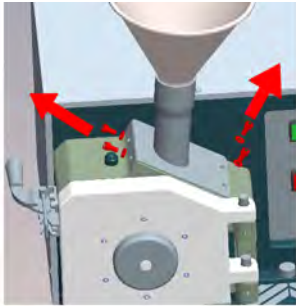

5. ➤ Insert the protected funnel (22) and fasten it with the four M6x12 hexagon bolts and the washers.
6. ➤ Connect the device again to the mains.
⇒ The device is ready for operation.

4.6.3 Converting from protected funnel to standard funnel

1. ➤ Close the cutting mill.
2. ➤ Close the funnel lid (21).

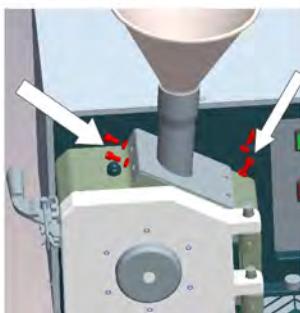
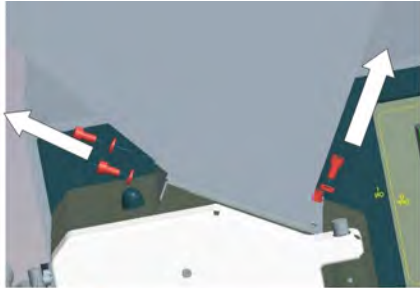

3. ➤ Switch the control switch (19) on the back of the device to 0.
4. ➤ Remove the mains plug (20).
5. ➤ Unscrew the four M6x12 hexagon bolts fastening the protected funnel (22) to the upper part of the housing (2) using a hexagon socket screw key and lift off the protected funnel (22).

6. ➤ Insert the standard funnel (1) and fasten it with the four M6x12 hexagon bolts and the washers.
7. ➤ Connect the device again to the mains.
8. ➤ Switch the control switch (19) on the back of the device to AUTO.
⇒ The device is ready for operation.

4.7 Electrical connection

Before establishing the connection, compare the voltage and current values stated on the type plate with the values of the mains system to be used.

(see ↪ Chapter 3 'Technical data' on page 18).

Installation

If the STOP button lights up red after **connection to a three-phase power system** and switching the control switch (19) to AUTO, the direction of rotation must be corrected. To do this, two phases in the mains plug must be reversed.



DANGER!

Changes to the connection line may only be made by a qualified person.

5 Initial start-up

5.1 Before switching on for the first time



1. ➔ Connect the device to the mains with the mains plug (20).
2. ➔ Switch the control switch (19) on the back of the device to AUTO. The START button must light up green. If the STOP button lights up red, see [Chapter 4.7 'Electrical connection'](#) on page 23.



3. ➔ Switch the control switch (19) on the back of the device to AUTO.

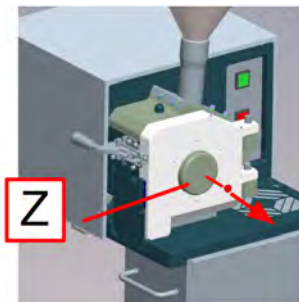

4. ➔ Remove the cover cap (Z) of the central bore hole in the closing lid (6).

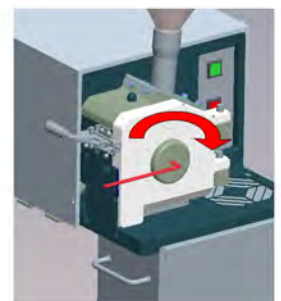

5. ➔ Insert the hexagon socket screw key provided through the central bore hole. Now turn the hexagon socket screw key to check if the rotor (3) is turning freely.

Initial start-up

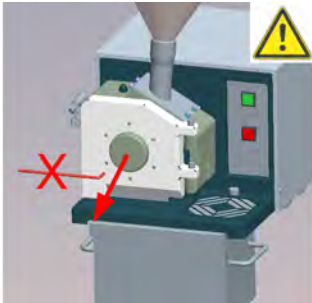

6. ➤ Remove the hexagon socket screw key again!
7. ➤ If the rotor (3) is not turning freely, proceed as described in [Chapter 6.1.3 'Setting the gap width of the knives' on page 30.](#)



NOTICE!

This check must also be carried out every time the rotor (3), the fixed knives (4, 5, 9) and the sieve cassette (7) are changed!

5.2 Switching on

1. ➤ Check again that the cutting mill is firmly fastened.
2. ➤ Check that the funnel (1, 22) is firmly mounted and closed.
3. ➤ Push in the collecting vessel (8) or the adapter for the sample exhaust system (27) (see [Chapter 6.5 'Sample exhaust system with cyclone separator' on page 39.](#))
4. ➤ Check if the latch clamp (13) is closed.
5. ➤ Switch the control switch (19) on the back of the device to AUTO, the START button must light up green.

5.3 Function check

Switch on the device by pressing the START button. This front closing lid (6) is now locked.

→ The cutting mill starts up.



NOTICE!

Switch the device off immediately if there is an audible metal contact noise. This can happen if the fixed knives are set incorrectly. An indication of this could be shiny areas on the rotor, which show where the fixed knives must be readjusted. (See [Chapter 6.1.2 'Inserting / changing the fixed knives' on page 29](#))

5.4 Switching off

Press the STOP button to switch off the device. After waiting a few seconds the closing lid (6) can be opened.

Switch off the main switch (19) if the cutting mill is to be idle for a longer period of time (e.g. overnight).



The switch (19) on the back is not a main switch but rather a control switch. Therefore the mains plug (20) must be plugged out in order to safely disconnect the supply voltage.



CAUTION!

Never unlock the latch clamp (13) during operation!

Risk of severe and permanent damage to the rotor (3).

Using the device

6 Using the device

6.1 Preparing a comminution

6.1.1 Opening the cutting mill

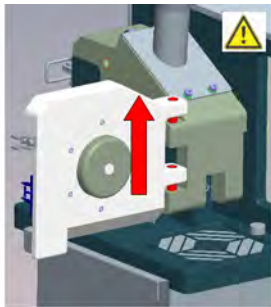

1. ➤ Switch the control switch (19) on the back of the device to AUTO.
2. ➤ Unlock the latch clamp (13).
3. ➤ Open the closing lid (6). It is possible to lift the closing lid (6) out of the hinge after opening. However this is only necessary, for example, for cleaning.



4. ➤ Make sure that the closing lid (6) is fully open!
Slowly swivel open the upper part of the housing (2) until it is resting on the rubber buffer.

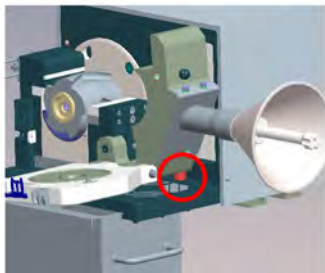

6.1.2 Inserting / changing the fixed knives

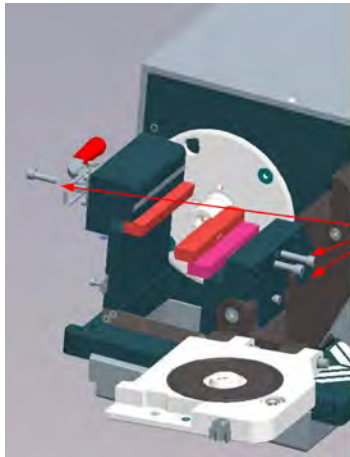

1. ➔ Open the cutting mill (see [Chapter 6.1.1 'Opening the cutting mill'](#) on page 28)
2. ➔ When inserting or changing the fixed knives (4, 5, 9) the rotor (3) and the sieve cassette (7) must be removed (see [Chapter 6.1.4 'Inserting / changing a rotor'](#) on page 31 and [Chapter 6.1.5 'Inserting / changing a sieve cassette'](#) on page 33).
3. ➔ Loosen the retaining screws (A) to change or remove the fixed knives (4, 5, 9).
4. ➔ When inserting, fasten the fixed knives (4, 5, 9) with the retaining screw (A).
5. ➔ After mounting the rotor (3) (see [Chapter 6.1.4 'Inserting / changing a rotor'](#) on page 31) set the gap width of the knives (see [Chapter 6.1.3 'Setting the gap width of the knives'](#) on page 30).

6.1.2.1 Installation position of the fixed knives

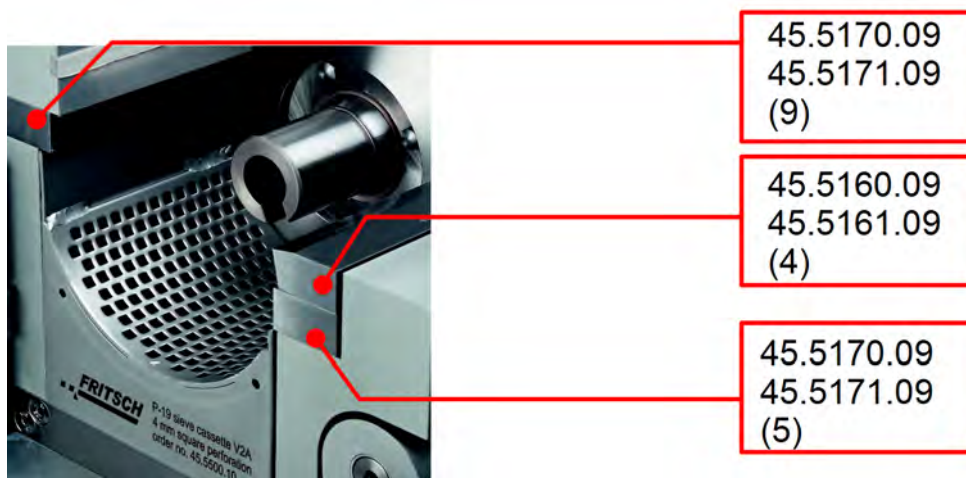

- (9) Fixed knife 2
- (4) Fixed knife 1
- (5) Fixed knife 2

Using the device

6.1.2.2 Installation position of the fixed knives with tungsten carbide cutting edge

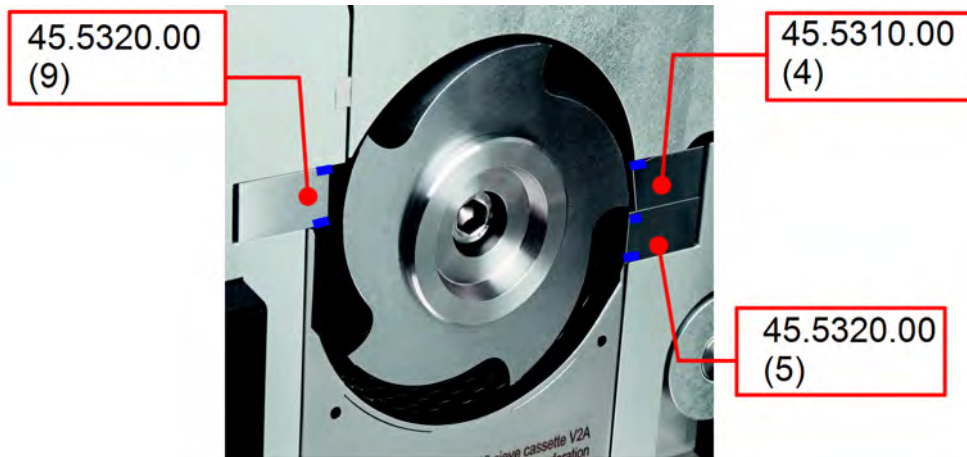

- (9) Fixed knife 2
- (4) Fixed knife 1

(5) Fixed knife 2



NOTICE!

Observe the position of the strips of hardmetal tungsten carbide. These are marked in BLUE in the image above.

6.1.3 Setting the gap width of the knives

The knife gap is set at the factory to approx. 0.2 mm.

1. ➤ Open the cutting mill (see ↗ *Chapter 6.1.1 'Opening the cutting mill' on page 28*) but set the control switch (19) on the back of the device to HAND.
2. ➤ Loosen the middle retaining screws (A) on all 3 fixed knives (4, 5, 9) and unscrew them slightly.
3. ➤ Turn the rotor (3) so that the rotor knife and the fixed knife (4, 5, 9) are exactly opposite each other.

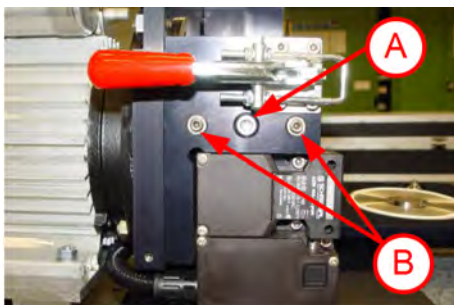

- A Retaining screw to fasten and loosen the fixed knife when setting the gap width of the knives.
- B Threaded pins to set the cutting gap.

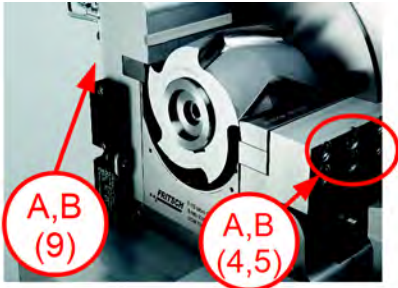

- A, B (9) Retaining screw (A) and threaded pins (B) for fixed knife (9)
- A, B (4, 5) Retaining screws (A) and threaded pins (B) for fixed knife (4, 5)

4. → Screw in the right and left threaded pins (B) beside the retaining screw (A) equally until the fixed knives (4, 5, 9) come up against the rotor knives.
5. → Then turn the threaded pins (B) evenly back by $\frac{1}{4}$ of a turn and retighten the retaining screw (A).
6. → Set all 3 fixed knives (4, 5, 9) in this way.

A knife gap of approx. 0.2 mm is then set using this method. This can be checked using a feeler gauge. (0.2 mm, approx. 2 sheets of printing paper, DIN A4 80 g)



NOTICE!

The fixed knives (4, 5, 9) must run parallel to the rotor knives so that the cutting load is distributed evenly across the whole length.

7. → Insert the sieve cassette (7) (see ↪ Chapter 6.1.5 'Inserting / changing a sieve cassette' on page 33).
8. → Close the cutting mill (see ↪ Chapter 6.1.6 'Closing the cutting mill' on page 34).



NOTICE!

Check if the rotor (3) is turning freely (see ↪ Chapter 6.1.7 'Checking if the rotor is turning freely' on page 34).

If this is not the case, proceed as described in ↪ Chapter 6.1.3 'Setting the gap width of the knives' on page 30.

This check must also be carried out every time the rotor (3) is changed!

6.1.4 Inserting / changing a rotor



CAUTION!

Risk of injury!

Beware of the sharp edges of the rotor!

Wear safety gloves when changing the rotor!

Using the device

1. ▶ Open the cutting mill (see ↪ Chapter 6.1.1 'Opening the cutting mill' on page 28).

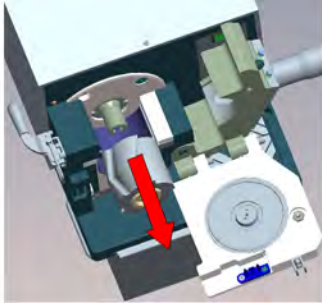

2. ▶ Pull the rotor (3) forwards, wearing **safety gloves**. If the rotor (3) jams somewhat, lever it out carefully.

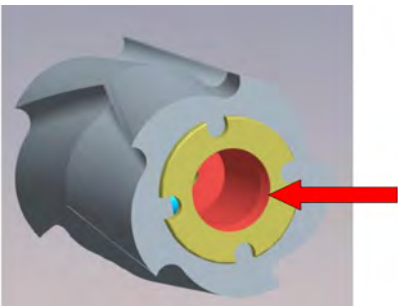

3. ▶ Clean the cone-shaped rotor holders (3).

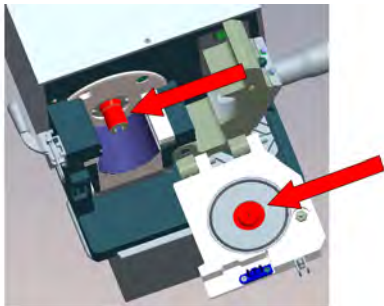

4. ▶ Clean both cone-shaped holders (cones) in the closing lid (6) and on the holder.

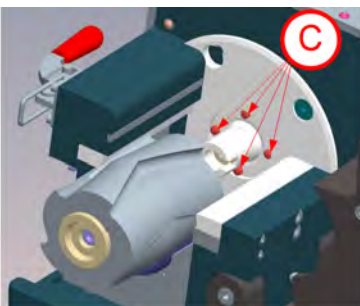

5. ▶ Push the rotor (3) onto the rotor holder. Turn it clockwise until it engages in the 4 driving pins (C) on the back. (The control switch (19) must be at AUTO)

6. ➔ Close the cutting mill (see ↪ Chapter 6.1.6 'Closing the cutting mill' on page 34).



NOTICE!

Check if the rotor (3) is turning freely (see ↪ Chapter 6.1.7 'Checking if the rotor is turning freely' on page 34).

If this is not the case, proceed as described in ↪ Chapter 6.1.3 'Setting the gap width of the knives' on page 30.

This check must also be carried out every time the rotor (3) is changed!

6.1.5 Inserting / changing a sieve cassette

1. ➔ Open the cutting mill (see ↪ Chapter 6.1.1 'Opening the cutting mill' on page 28).
2. ➔ Pull out the sieve cassette (7) to the front. The rotor (3) must not be removed.



If necessary, use the pulling tool (X) 45.5550.10 to pull out the sieve cassette (7): Insert the pulling tool into the two holes of the sieve cassette (7) past the bends of the pulling tool. While inserting the pulling tool, move it slightly up and down.

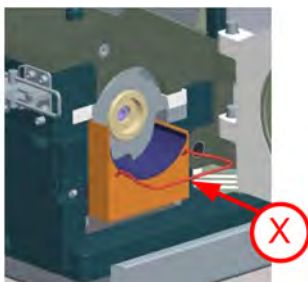

3. ➔ If the sieve cassette (7) is jammed, remove the comminution material under the fixed knife (9) on the left side of the housing with a screwdriver.
4. ➔ Before pushing in the sieve cassette (7) clean the cutting chamber thoroughly, so that everything can be closed tightly again.
5. ➔ Close the cutting mill (see ↪ Chapter 6.1.6 'Closing the cutting mill' on page 34).

6.1.5.1 Selecting the sieve cassette

Coarse material should be roughly crushed with the coarse 2-4 mm sieve and comminuted in the second work step to the desired final fineness. The sample exhaust system with cyclone separator (optional accessory, see ↪ Chapter 6.5 'Sample exhaust system with cyclone separator' on page 39) can be used for fine comminution < 2 mm.

Using the device

6.1.6 Closing the cutting mill

1. ➤ Before closing the cutting mill, clean the cutting chamber, the contact surfaces of the housing and, in particular, the locking surfaces of the lock.
2. ➤ Swivel the upper part of the housing (2) slowly closed until it is resting on the lower part of the housing (10).
3. ➤ Close the closing lid (6).
4. ➤ Lock the latch clamp (13).
5. ➤ Switch the control switch (19) on the back of the device to HAND.



6.1.7 Checking if the rotor is turning freely

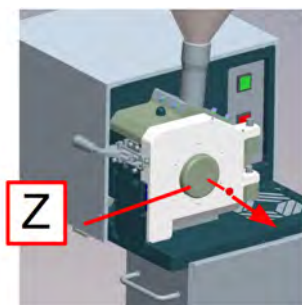

- To check if the rotor is turning freely, the closing lid (6) must be closed. (See [Chapter 6.1.6 'Closing the cutting mill' on page 34](#))
- Remove the cover cap (Z) of the central bore hole in the closing lid (6).

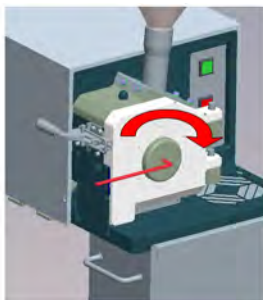

- Guide the hexagon socket screw key provided through the central bore hole in the closing lid (6).
- Now turn the hexagon socket screw key to check if the rotor (3) is turning freely.

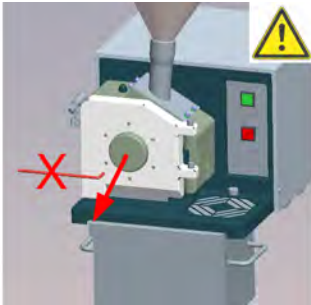

- Remove the hexagon socket screw key again **immediately!**
- If the rotor (3) is not turning freely, proceed as described in [Chapter 6.1.3 'Setting the gap width of the knives' on page 30.](#)



NOTICE!

This check must also be carried out every time the rotor (3) and the fixed knives (4, 5, 9) are changed!

6.2 Comminution procedure with standard funnel



CAUTION!

Wear safety goggles for comminution using the standard funnel!

There is a risk of particles from the funnel being projected, in the case of free-flowing material.

1. ➤ Switch the control switch (19) on the back of the device to AUTO.
2. ➤ Close the cutting mill (see [Chapter 6.1.6 'Closing the cutting mill' on page 34.](#))
3. ➤ Push in the collecting vessel (8).
4. ➤ Pull the plunger (26) out fully.
5. ➤ Switch on the device → press the green Start button (see [Chapter 5.2 'Switching on' on page 26.](#))

6. ➤ Add some comminution material.

⇒ An operating noise becomes audible.

The quantity of comminution material is based on the particle feed size and the grindability of the comminution material. It is best to start with small quantities and increase them depending on the success of the comminution.

7. ➤ If necessary, press the comminution material into the cutting chamber with the plunger (26).
8. ➤ When the operating noise becomes quieter, the comminution procedure is complete.

⇒ More comminution material can be added in.

Using the device

6.2.1 Using the plunger



The plunger has 2 different sides for feeding the sample material in the funnel to the grinding chamber. On the one hand, the smooth, round side is suitable for finer material. On the other hand, the cross-shaped, thinner side is suitable for long, fibrous material, like straw.

6.3 Comminution procedure with the protected funnel

1. ➤ Switch the control switch (19) on the back of the device to AUTO.
2. ➤ Close the cutting mill (see [Chapter 6.1.6 'Closing the cutting mill'](#) on page 34).
3. ➤ Push in the collecting vessel (8).
4. ➤ Pull the sample pusher (24) out fully.
5. ➤ Move the plunger (23) into the lower position.
6. ➤ Flip open the funnel lid (21), add some comminution material and close the lid again.

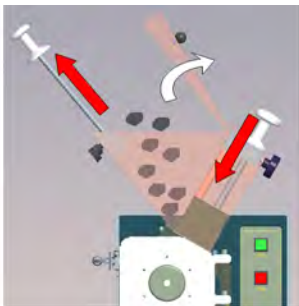

The quantity of comminution material is based on the particle feed size and the grindability of the comminution material. It is best to start with small quantities and increase them depending on the success of the comminution.

7. ➤ Switch on the device → press the green Start (34) button (see [Chapter 5.2 'Switching on'](#) on page 26).
8. ➤ Move the sample pusher (24) down towards the plunger (23) until the comminution material is in front of the plunger (23).
9. ➤ Pull the plunger (23) upwards and move the sample pusher (24) fully downwards until the comminution material falls into the cutting chamber.

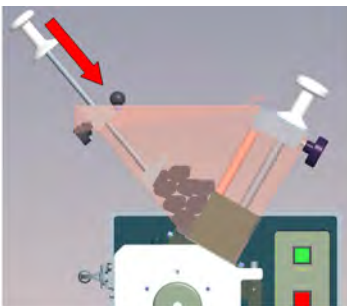

⇒ a slight operating noise becomes audible.

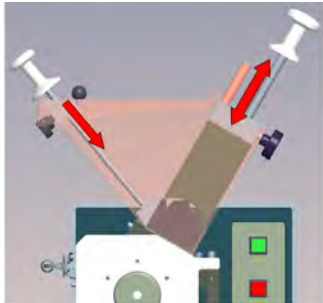

- 10.** ▶ Leave the sample pusher (24) down and move the plunger (23) downwards.
 - ⇒ The operating noise becomes louder.
- 11.** ▶ Make pumping movements with the plunger (23). These pumping movements draw in and press out air through the blower filter above the collecting vessel. This air feeds the comminution material through the sieve or lifts it off the sieve and feeds it to the process again.
- 12.** ▶ When the operating noise becomes quieter, the cutting procedure is complete.
 - ⇒ More comminution material can be added in.

6.4 Overload of the cutting mill

When filling and making downward movements with the plunger (23) the working noise must be observed. The sound level is nearly identical to the load on the machine. You can clearly hear from the pitch when the mill reduces speed due to overload.

Pulling the plunger (23) out on time reduces the load on the mill and protects the rotor (3), the fixed knives (4, 5, 9) and the sieve cassette (7).



NOTICE!

If the cutting mill is overloaded, the motor protection switch switches the device off.

The red Stop button lights up to indicate overload.

Then proceed as follows:

- 1.** ▶ Switch the control switch (19) on the back of the device to 0.
- 2.** ▶ Disconnect the cutting mill from the mains (remove the mains plug (20) from the socket).
- 3.** ▶ Allow the device to cool down.
- 4.** ▶ Unscrew the 3 screws fastening the motor cover (14).

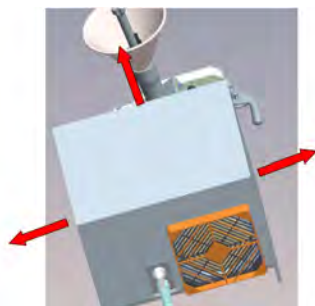

Using the device



5. ➤ Lift the motor cover (14) off carefully.



6. ➤ Press the blue Reset switch. This must be set to "H".

7. ➤ Replace the motor cover (14) and screw it tight.

8. ➤ Connect the device again to the mains.

9. ➤ Switch the control switch (19) on the back of the device to AUTO.

⇒ the Start button lights up green. The device is ready for operation.

6.5 Sample exhaust system with cyclone separator



CAUTION!

Hearing damage!

Wear hearing protection during sample extraction with the cyclone separator!

(Optional accessory order number: 45.5900.00)

The sample exhaust system with cyclone separator can be used for fine comminution.

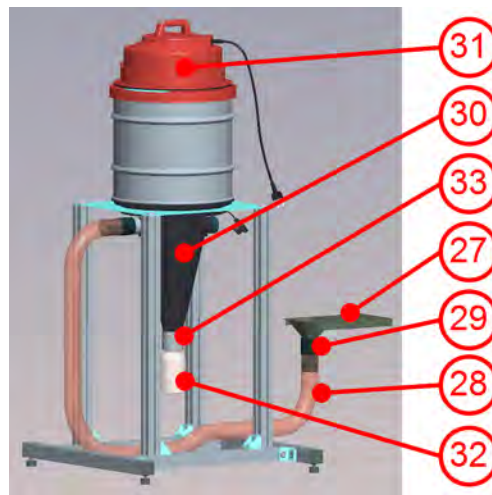

- 27 Adapter for exhaust system
- 28 Connection hose
- 29 Rubber sleeve
- 30 Cyclone separator (air separator)
- 31 Power vacuum
- 32 Sample bottle
- 33 Adapter for sample bottle

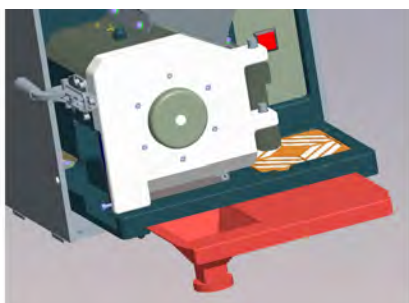

1. Push the adapter for the exhaust system (27) as well as the collecting vessel (8) into the lower part of the housing (10).



When using the cyclone separator, the filter above the collecting vessel is automatically covered by the adapter.

Using the device

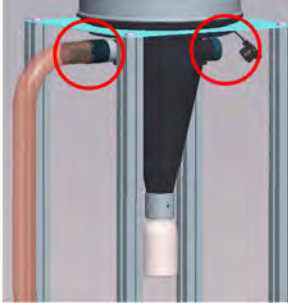

2. Attach one end of the connection hose (28) with the rubber sleeve (29) to the adapter (27) and the other end to the cyclone separator (30).



NOTICE!

There are 2 opposing hose connections on the cyclone separator (30). Do not use the sealed connection; leave it closed. This would increase the noise level!

3. Close the cutting mill with mounted standard funnel (1) (see [Chapter 6.1.6 'Closing the cutting mill' on page 34](#)).
4. Screw the sample bottle (31) onto the adapter (33) on the bottom of the cyclone separator (30); make sure the connection hose is firmly connected and switch on the exhaust system.
5. Switch on the cutting mill (see [Chapter 5.2 'Switching on' on page 26](#)).
6. Add a little comminution material by hand and observe the operating noises. If the motor speed decreases audibly, reduce the supply of comminution material. A fast vortex of comminution material must form in the collection bottle.

The quantity of comminution material is based on the particle feed size and the grindability of the material. It is best to start with small quantities and increase them depending on the success of the comminution.

**NOTICE!**

When the sample bottle (32) is 2/3 full, stop the comminution. To do this, switch off the cutting mill (see [Chapter 5.4 'Switching off'](#) on page 26) and the sample exhaust system. Then empty the sample bottle (32).

If comminution has not stopped when the bottle is 2/3 full, the effectiveness of the classifier is impaired and material will gradually clog the filter of the sample exhaust system.

If the vortex of comminution material in the collection bottle slows down, this means that the air throughput or air flow rate has decreased:

- grinding chamber is too full
- the sieve has to be cleaned and / or
- the filter of the exhaust system has to be cleaned.

**NOTICE!**

The fine material (fine dust) of the sample collects in the filter of the sample exhaust system. Clean the filter from time to time by vacuuming or blowing out.

The sample exhaust system is recommended especially in combination with the standard funnel (1) for bulk and long solids.

Cleaning

7 Cleaning

7.1 Housing

The cutting mill can be wiped down with a damp cloth when it is switched off. Disconnect the mains plug (20) from the electricity.



DANGER!

Do not allow any liquids to flow into the device.

7.2 Cutting chamber

Clean the cutting chamber with a dust exhaust system and brush and also with compressed air, if necessary.



CAUTION!

Beware of dust exposure caused by cleaning with compressed air!



CAUTION!

Risk of entrapment!

When the control switch is at the "HAND" position, the rotor can be turned freely in both directions!

1. ➤ Switch the control switch (19) on the back of the device to HAND.
2. ➤ Unlock the latch clamp (13).
3. ➤ Open the closing lid (6) fully. This can be lifted out of the hinge at an opening angle of 90° for cleaning.

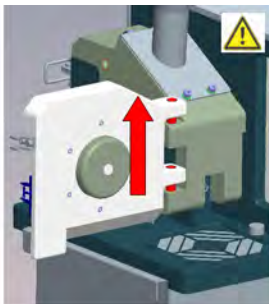

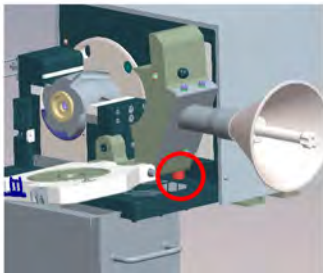

4. ➤ Slowly swivel open the upper part of the housing (2) with the closing lid (6) fully open, until it is resting on the rubber buffer.
5. ➤ Clean the cutting chamber.

7.3 Funnel

Clean the funnels (1, 22) with a dust exhaust system and brush and also with compressed air, if necessary.

7.3.1 Standard funnel (1)

1. ➤ With the cutting chamber open, vacuum out the funnel from below
2. ➤ Clean the funnel from above.

Cleaning

7.3.2 Protected funnel (22)

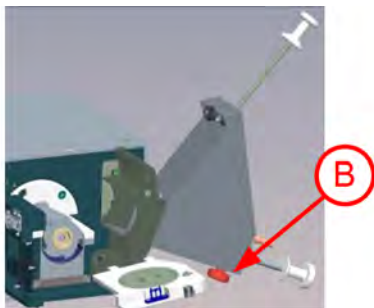
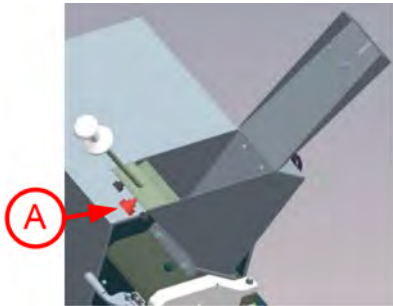

1. ➤ Switch the control switch (19) on the back of the device to 0.
2. ➤ Pull the sample pusher (24) out of the protected funnel (22) until it stops and fasten it with knurled screw (A).
3. ➤ Open the funnel lid (21).
4. ➤ Clean the protected funnel (22) from above.
5. ➤ Close the funnel lid (21).
6. ➤ Pull the plunger (23) out of the protected funnel (22) until it stops and fasten it with knurled screw (B).
7. ➤ Open the cutting chamber as described above.
8. ➤ Clean the protected funnel (22) from below.

If necessary!

It is also possible to remove the plunger (23) and the sample pusher (24) for cleaning. Switch the control switch (19) on the back of the device to 0 and disconnect the mains plug (20) from the electricity.

7.3.2.1 Removing sample pusher (24)

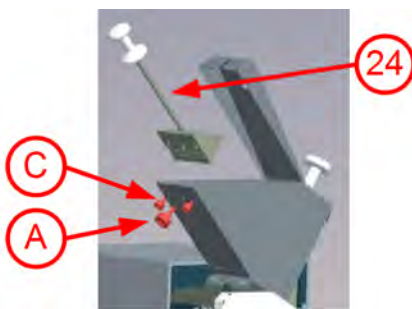

1. ➤ Open the funnel lid (21).
2. ➤ Unscrew the knurled screws (C) and (A).
3. ➤ The sample pusher (24) can be taken out.
4. ➤ Install in reverse order.

7.3.2.2 Removing the plunger (23)



1. ➤ Open the funnel lid (21).
2. ➤ Unscrew the cross-head screws (D) with a screwdriver.
3. ➤ Close the funnel lid (21).

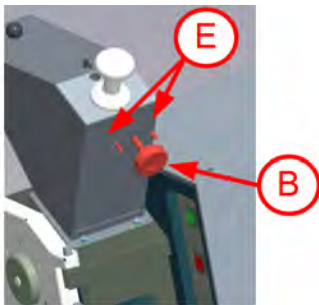

4. ➤ Unscrew the Torx screws (E) with a screwdriver.
5. ➤ Unscrew the knurled screw (B).

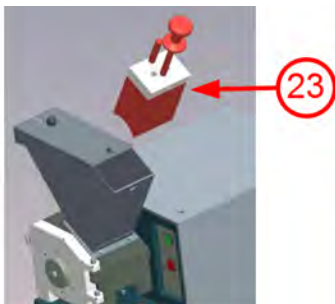

6. ➤ The plunger (23) can be taken out.
7. ➤ Install in reverse order.

7.4 Collecting vessel

Pull out the collecting vessel (8) and clean it. It can be vacuumed or wiped down with a damp cloth.



NOTICE!

Close the cutting mill after cleaning and check for proper functioning. See [Chapter 5 'Initial start-up'](#) on page 25.



NOTICE!

Make sure that the parts sit firmly when assembling.

Cleaning

7.5 Cleaning the sample exhaust system and cyclone separator



The exhaust system can be disassembled and cleaned after opening the clips (F). To open and clean the cyclone separator, 4 screws in the inner part of the base must be loosened.

7.6 Cleaning the filter foam mat (B)

1. ➤ Vacuum the filter foam mat with the dust exhaust system
2. ➤ Subsequently wash it out with water. If necessary, you could use a tenside for cleaning.
3. ➤ Allow the foam mat to air-dry!

8 Maintenance

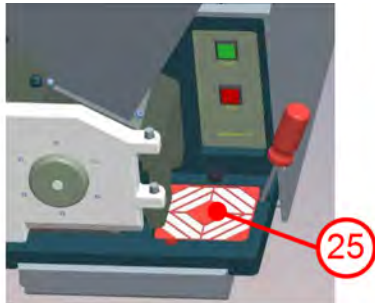

- 25 Exhaust filter
- A Filter holder
- B Filter foam mat

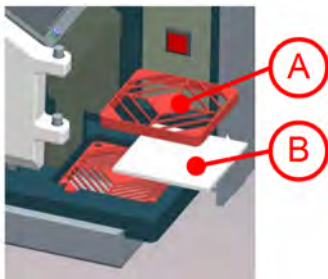

NOTICE!

Before starting maintenance work, that does not require mains voltage, unplug the mains plug (20) and protect the device against being unintentionally switched back on again!

Indicate maintenance work with warning signs.

The most important element of maintenance of the cutting mill is regular cleaning (↪ *Chapter 7 'Cleaning' on page 42*).



We recommend keeping a safety logbook ↪ Chapter 13 'Safety logbook' on page 58, where all work (maintenance, repairs.....) performed on the device is entered.

Maintenance

Function / Functional part	Task	Test	Maintenance interval
Exhaust filter (25)	Filtering exhaust air	Clean exhaust filter (25). To do this, lever out the filter holder (A) with a screwdriver or similar. Beat the filter foam mat (B). Clean using compressed air or dust exhaust system. Replace the filter foam mat (B) if it is very heavily soiled. Article number: 90.0740.16 filter foam mat.	Before every comminution
Safety lock (11)	Locking the closing lid (6)	Is the closing lid (6) locked when control switch (19) is set to 0? If NOT → safety lock (11) defective. Disconnect the device from the mains immediately. Replace the safety lock (11).	Before each use
Safety switch (15)	Protecting the lower opening of the cutting chamber	Is the cutting mill running without the collecting vessel (8) or the adapter for exhaust system (27)? If YES → safety switch (15) defective. Disconnect the device from the mains immediately. Replace the safety switch (15).	Before each use
START button	Indicating readiness for operation	Does the START button light up green if the control switch (19) is set to AUTO or HAND? If not, see Chapter 11 'Guarantee terms' on page 54.	Before each use
Rotor (3)	Comminuting material	Is the rotor (3) sharp? Maintenance: resharpen	Before each use
Fixed knives (4, 5, 9)	Comminuting material	Are the fixed knives (4, 5, 9) sharp? Check visually! Maintenance: resharpen	Before each use
Cutting gap	Cutting procedure	Measure gap width. For setting see Chapter 6.1.3 'Setting the gap width of the knives' on page 30.	Whenever rotor and fixed knives are changed
Cones	Centring rotor (3)	Check cones for cleanliness and grooves. See Chapter 6.1.4 'Inserting / changing a rotor' on page 31.	Whenever rotor is changed
Filter, sieve and sample exhaust system	Filtering exhaust air	Vortex of comminution material in the collection bottle slows down! For cleaning see Chapter 7 'Cleaning' on page 42!	Before each use

Wartungshinweis Maintenance

FRITSCH

Fritsch GmbH
Laborgerätekabine
Industriest.-8
D-55743 Idar-Oberstein
Telefon 06784 / 70-0
Telefax 06784 / 70-11

in diesen Spalt alle 10-20 Betriebsstunden ca. 1ml Öl einfüllen (Füllrichtung mit Öl imprägnieren)
please fill in this slit ca. 1ml oil after 10-20 hours of operation oil impregnate the felt packing

diese Flächen immer reinigen (auch am Gehäuseoberteil)
please keep this surfaces always clean also at housing upper part

auf Konus und Zylinderfläche (auch beim Rotor) etwas Öl geben
oil the cone and the cylinder surface (also rotor surfaces)

Wartungshinweis Maintenance

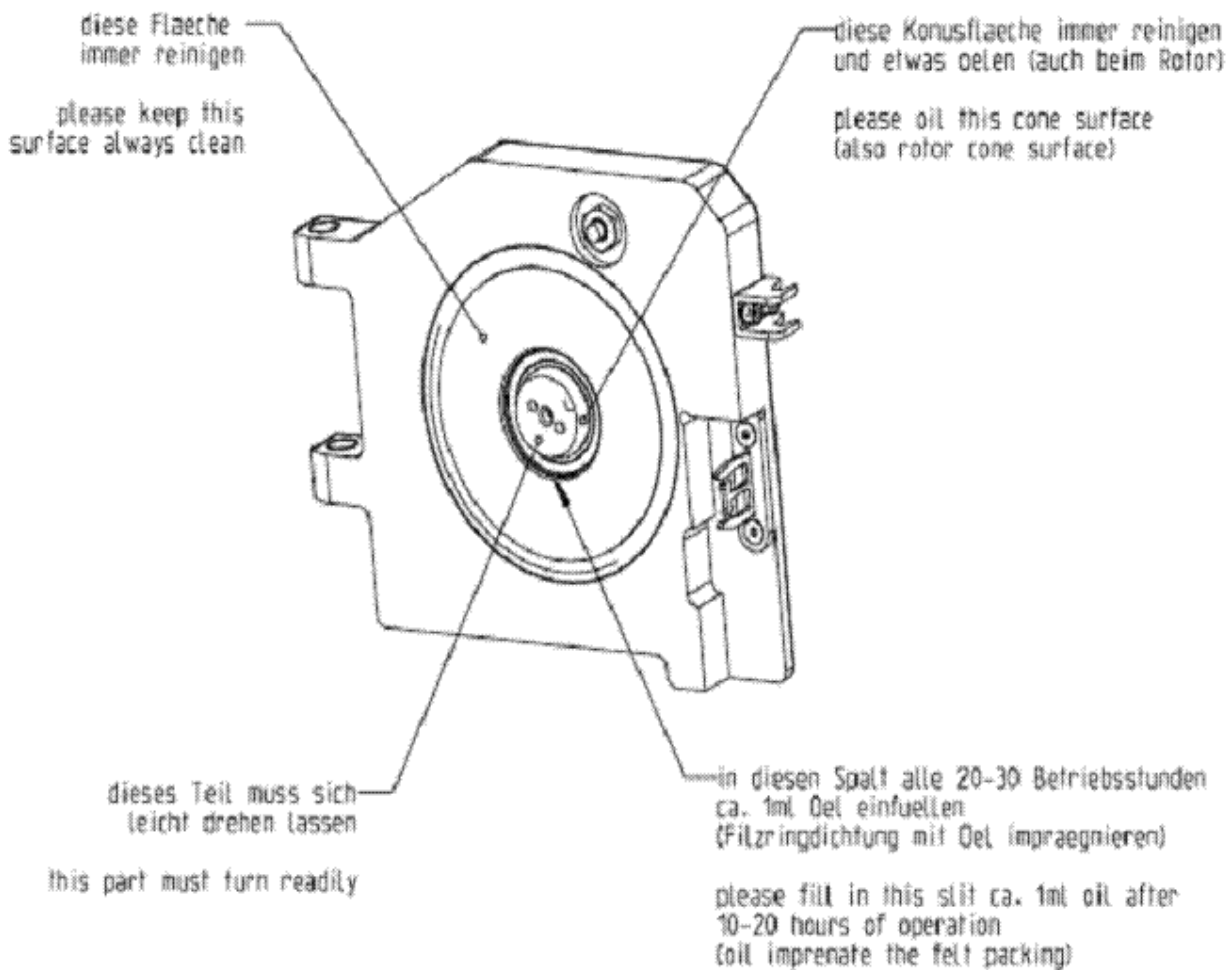

9 Repairs

DANGER!
Mains voltage!

- Before beginning with repair work, unplug the mains plug and protect the device against being unintentionally switched back on.
- Indicate repair work with warning signs.
- Repair work may only be performed by specialised personnel.
- Put safety equipment back into operation after maintenance work.

9.1 Checklist for troubleshooting

Fault description	Cause	Remedy
Start button does not light up green	No mains connection	Plug in mains plug (20)
	The control switch (19) is at 0	Set the control switch (19) to AUTO or HAND
	Incorrect direction of rotation	Reverse two phases (↪ Chapter 4.7 'Electrical connection' on page 23
	Socket fuse is faulty	Check socket fuse
	Device fuse blown	Remove the housing and replace the fuse
START button is pressed but mill does not start up	Closing lid (6) not closed properly	Clean contact surface, close closing lid (6)
	Collecting vessel (8) or adapter for exhaust system (27) not inserted properly	Insert collecting vessel (8) or adapter for exhaust system (27) properly → until safety switch (15) engages.
	The control switch (19) is set to HAND.	Switch the control switch to AUTO.
	Coarse samples were added to the machine first and are blocking rotor start-up.	Open grinding chamber and remove sample material. → Switch on device before adding sample.
Mill stops running	Motor safety switch has triggered	Motor safety switch (see ↪ Chapter 6.4 'Overload of the cutting mill' on page 37)
STOP button lights up red	Incorrect direction of rotation	Swap two phases in the mains plug (20) (↪ Chapter 4.7 'Electrical connection' on page 23)
	Too much comminution material in grinding chamber	Reduce feeding amount

Repairs

Fault description	Cause	Remedy
Comminution material is escaping	Material is extremely fine	Insert sample exhaust system (see Chapter 6.5 'Sample exhaust system with cyclone separator' on page 39)
Runs unevenly with strong vibrations	Rotor imbalance	Cones soiled (see Chapter 6.1.4 'Inserting / changing a rotor' on page 31)
	Bearing in closing lid (6) defective	Replace bearing
	Pieces broken off rotor (3)	Replace rotor (3) (Chapter 6.1.4 'Inserting / changing a rotor' on page 31)
	Rotor and fixed knives are touching each other (audible metal contact noise)	Switch device off immediately, disconnect from mains, check gap widths and correct. Check rotor and fixed knives for damage. (See Chapter 6.1.2 'Inserting / changing the fixed knives' on page 29)

10 Disposal

It is hereby confirmed that FRITSCH has implemented the directive 2002/95/EC of the European Parliament and Council from 27th January 2003 for the limitation of the use of certain dangerous substances in electrical and electronic devices.

FRITSCH has registered the following categories according to the German electrical and electronic equipment act, section 6, paragraph 1, clause 1 and section 17, paragraphs 1 and 2:

Mills and devices for the preparation of samples have been registered under category 6 for electrical and electronic tools (except for large stationary industrial tools).

Analytical devices have been registered under category 9, monitoring and control instruments.

It has been accepted that FRITSCH is operating only in the business-to-business area. The German registration number for FRITSCH is WEEE reg. no. DE 60198769

FRITSCH WEEE coverage

Since the registration of FRITSCH is classified for bilateral transactions, no legal recycling or disposal process is described. FRITSCH is not obliged to take back used FRITSCH devices.

FRITSCH declares it is prepared to take back used FRITSCH devices for recycling or disposal free of charge whenever a new device is purchased. The used FRITSCH device must be delivered free of charge to a FRITSCH establishment.

In all other cases FRITSCH takes back used FRITSCH devices for recycling or disposal only against payment.

11 Guarantee terms

Guarantee period

As manufacturer, FRITSCH GmbH provides – above and beyond any guarantee claims against the seller – a guaranty valid for the duration of two years from the date of issue of the guarantee certificate supplied with the device.

Within this guarantee period, we shall remedy all deficiencies due to material or manufacturing defects free of charge. Rectification may take the form of either repair or replacement of the device, at our sole discretion. The guarantee may be redeemed in all countries in which this FRITSCH device is sold with our authorisation.

Conditions for claims against the guarantee

This guarantee is subject to the condition that the device is operated according to the instructions for use / operating manual and its intended use.

Claims against the guarantee must include presentation of the original receipt, stating the date of purchase and name of the dealer, together with the complete device type and serial number.

For this guarantee to take effect, the answer card entitled "Securing of Guarantee" (enclosed with the device) must be properly filled out and despatched without delay after receipt of the device and be received by us within three weeks or alternatively, online registration must be carried out with the above-mentioned information.

Reasons for loss of the guarantee

The guarantee will not be granted in cases where:

- Damage has arisen due to normal wear and tear, especially for wear parts, such as: Crushing jaws, support walls, grinding bowls, grinding balls, sieve plates, brush strips, grinding sets, grinding disks, rotors, sieve rings, pin inserts, conversion kits, sieve inserts, bottom sieves, grinding inserts, cutting tools, sieve cassettes, sieve and measuring cell glasses.
- Repairs, adaptations or modifications were made to the device by unauthorized persons or companies.
- The device was not used in a laboratory environment and/or has been used in continuous operation.
- Damage is present due to external factors (lightning, water, fire or similar) or improper handling.
- Damage is present that only insubstantially affects the value or proper functioning of the device.
- The device type or serial number on the device has been changed, deleted, removed or in any other way rendered illegible
- The above-mentioned documents have been changed in any way or rendered illegible.

Costs not covered by the guarantee

This guarantee excludes any costs for transport, packaging or travel that accrue in the event the product must be sent to us or in the event that one of our specialist technicians is required to come to your site. Any servicing done by persons not authorised by us and any use of parts that are not original FRITSCH accessories and spare parts will void the guarantee.

Further information about the guarantee

The guarantee period will neither extend nor will a new period of guarantee begin in the event that a claim is placed against the guarantee.

Please provide a detailed description of the type of error or the complaint. If no error description is enclosed, we shall interpret the shipment as an assignment to remedy all recognisable errors or faults, including those not covered by the guarantee. Errors or faults not covered by the guarantee shall in this case be rectified at cost.

We recommend reading the operating manual before contacting us or your dealer, in order to avoid unnecessary inconvenience.

Ownership of defective parts is transferred to us with the delivery of the replacement part; the defective part shall be returned to us at buyer's expense.

**NOTICE!**

Please note that in the event that the device must be returned, the device must be shipped in the original Fritsch packaging. Fritsch GmbH denies all liability for any damage due to improper packaging (packaging not from Fritsch).

Any enquiries must include a reference to the serial number imprinted on the type plate.

12 Exclusion of liability

Before using the product, be sure to have read and understood this operating manual.

The use of the product requires technical knowledge; only commercial use is permitted.

The product may be used exclusively within the scope of applications set down in this operating manual and within the framework of guidelines put forth in this operating manual and must be subject to regular maintenance. In case of non-compliance, improper use or improper maintenance, the customer assumes full liability for the functional capability of the product and for damage or injury arising from violating these obligations.

The contents of this operating manual are subject in entirety to copyright law. This operating manual and its contents may not be copied, further distributed or stored in any form, in part or in whole, without the prior written consent of Fritsch.

This operating manual has been prepared to the best of our knowledge and checked for accuracy at the time of printing. FRITSCH GMBH assumes no guarantee or liability whatsoever for the accuracy or completeness of the contents of this operating manual, including but not limited to the implied warranties of merchantability and fitness for a particular purpose, unless liability is expressly prescribed by applicable laws or jurisprudence.

FRITSCH GMBH expressly reserves the right to modify and/or update this operating manual without prior notice. The same applies to modifications and improvements to the products described in this operating manual. It is the responsibility of the user to ensure that they have the current version of this operating manual. For more information, please contact your local FRITSCH GMBH distributor or Fritsch GmbH, Industriestr. 8, D-55473 Idar-Oberstein.

Not all parts shown here are necessarily installed in the product. The buyer is not entitled to delivery of these parts. If interested, please contact your local FRITSCH GMBH distributor or Fritsch GmbH, Industriestr. 8, D-55743 Idar-Oberstein.

FRITSCH GMBH takes the greatest care to ensure that the quality, reliability and safety of your products are continuously improved and adapted to the state of the art. The supplied products as well as this operating manual conform to the current state of the art when they leave the sphere of influence of FRITSCH GMBH.

By using the product the customer agrees with this and recognizes that defects, malfunctions or errors cannot be completely excluded. To prevent risk of damage to persons or property or of other direct or indirect damage, resulting from this or other causes, the customer must implement sufficient and comprehensive safety measures for working with the product.

Exclusion of liability

Fritsch GmbH excludes any liability, warranty, or other obligation to compensate for damages, regardless of whether this liability, warranty, or other obligation is explicit or implicit, contractual or arising from unlawful acts or prescribed contractually, by law, or otherwise. In no event shall the buyer be entitled to any compensation from Fritsch GmbH for any special, direct, indirect, coincidental or consequential damage, including but not limited to lost profits, lost savings, lost sales or financial loss of any kind or for compensation of third parties, for downtimes, for lost goodwill, for damage to or replacement of equipment and property, for costs or restoration of materials or goods related to the product or the use of our products, for other damage or injury to persons (including fatal injuries) or similar. The above exclusion of liability is limited by mandatory liability as prescribed by laws or jurisprudence. Liability for negligence is excluded in all cases.

No permission is given expressly, implicitly or otherwise for the use of patents, brands or other copyrights. We also assume no liability for copyright infringements or infringements of the rights of third parties arising from the use of this product.

Neither compliance with this operating manual nor the conditions and methods used during installation, operation, use and maintenance of the product can be monitored by Fritsch GmbH. Improper execution of the installation can result in property damage and thus endanger persons. Therefore, we assume absolutely no responsibility or liability for loss, damage or costs that result from errors at installation, improper operation or improper use or improper maintenance or are in any way connected to these.

14 Index

A	
Accident prevention	9
Authorised persons	9
B	
Basic structure	7
C	
Changing fixed knives	29
Changing the rotor	32
Changing the sieve cassette	33
Cleaning	42
Closing the cutting mill	34
Comminution procedures	35
Current consumption	18
D	
Dimensions	18
Direction of rotation detection	17
Disposal	53
E	
Electrical connection	23
Electrical fuses	19
Electrical safety	17
Exclusion of liability	56
Exhaust system	39
Explanation of signs	11
Explanation of symbols	11
F	
Fastening the Universal Cutting Mill	21
Final fineness	19
Funnel conversion	21
G	
Guarantee terms	54
H	
Hazardous points	16
M	
Mains voltage	18
Maintenance	47
Materials	19
Motor shaft power	19
O	
Operating noise	18
Operating principle	10
Overload	37
Overload protection	17
P	
Power consumption	18
Protection against restart	17
Protective equipment	15
R	
Removal funnel parts	44
Requirements for the user	9
S	
Safety information	11
Safety logbook	58, 59
Setting the gap width	30
Setting up	20
Skilled workers	9
T	
Transport	20
U	
Unpacking	20
W	
Warning information	11
WEEE	53
Weight	18
Working with the mill	28



© 2014

Fritsch GmbH

Milling and Sizing

Industriestraße 8

55743 Idar-Oberstein

Telephone: +49 (0)6784/ 70-0

Fax: +49 (0)6784/ 70-11

email: info@fritsch.de

Internet: www.fritsch.de
